

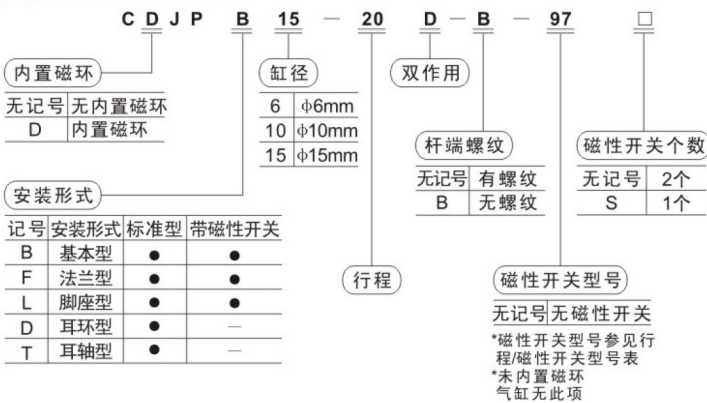
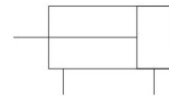

标准规格

缸径 (mm)	6	10	15
使用流体	空气		
动作方式	双作用		
最高使用压力 MPa	0.7		
最低使用压力 MPa	0.12	0.06	
环境和流体温度	无磁性开关: -10℃; 带磁性开关: -10℃~60℃		
缓冲	两端橡胶缓冲		
使用活塞速度	50~500mm/s		
行程公差 (mm)	+1.0 0		
*给油	不需要		
接管口径	M5×0.8		

*如给油, 请用透平1号油ISOVG32.

型号表示方法

符号

行程/磁性开关选择

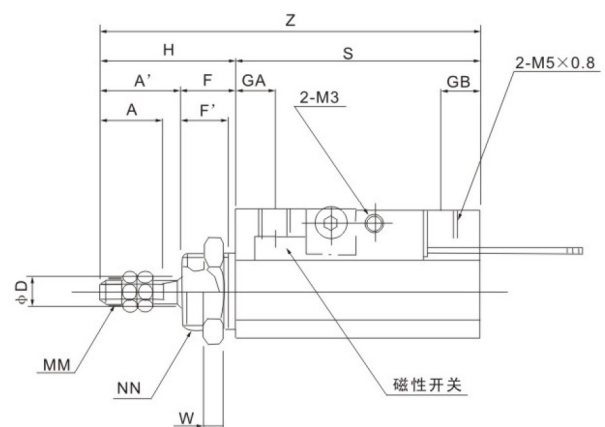
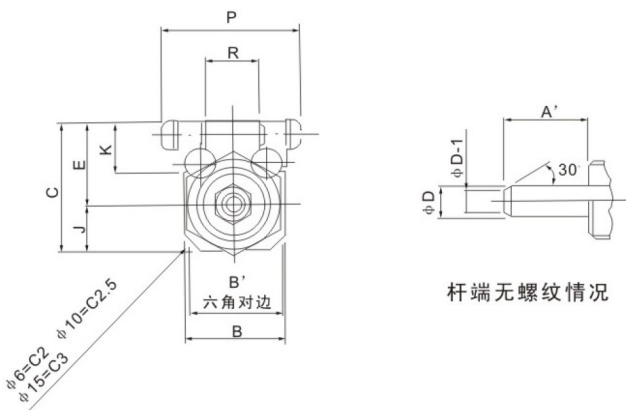
缸径 (mm)	标准行程 (mm)	*磁性开关型号	磁性开关安装件
6	5, 10, 15, 20	97	BP-1
10	5, 10, 15, 20, 25, 30		
15	5, 10, 15, 20, 25, 30		

 * 磁性开关的规格及特性可参阅磁性开关系列。
 导线长度表示记号: 无记号-0.5m, L-3m, Z-5m 例: 97A, 97AL.

外形尺寸图(毫米)
● CJPB · CDJPB

St: 气缸行程(毫米)

缸径 (mm)	A	A'	B	B'	φD	F	F'	GA	GB	H	J	K	MM	NN	R	S					W	Z					带磁性开关		
																5st	10st	15st	20st	30st		5st	10st	15st	20st	30st	C	E	P
6	7	9	14	14	3	8	6.5	6	6	17	6	8	M3×0.5	M10×1.0	7	30.5	35.5	40.5	45.5	-	3	47.5	52.5	57.5	62.5	-	16.5	10.5	20
10	10	12	15	17	5	8	6.5	6	7	20	7	8	M4×0.7	M12×1.0	8	30.5	35.5	40.5	45.5	55.5	4	50.5	55.5	60.5	65.5	75.5	20	13	21
15	12	14	20	19	6	10	8.5	6	7	24	9	8	M5×0.8	M14×1.0	10	30.5	35.5	40.5	45.5	55.5	5	54.5	59.5	64.5	69.5	79.5	24.5	15.5	23

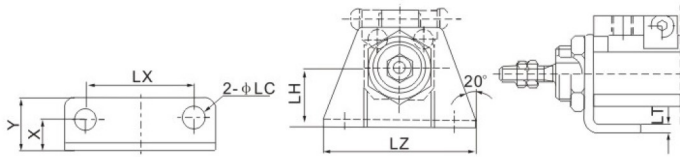
●脚座

适用缸径 (mm)	脚 座							
	零件号	LH	LT	LZ	LX	X	Y	φLC
6	CP-L006	11	1.6	28	20	6.5	10.5	3.4
10	CP-L010	13	1.6	33	24	7	12	4.5
15	CP-L015	18	2.3	43	30	10	16.5	4.5

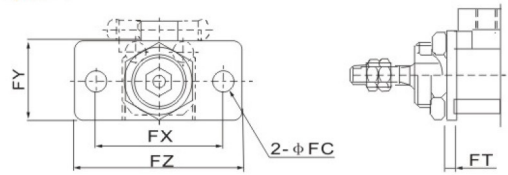
●法兰

适用缸径 (mm)	法 兰					
	零件号	FT	FX	FY	FZ	φFC
6	CP-F006	1.6	24	16	32	3.4
10	CP-F010	1.6	28	18	37	4.5
15	CP-F015	2.3	36	22	49	5.5

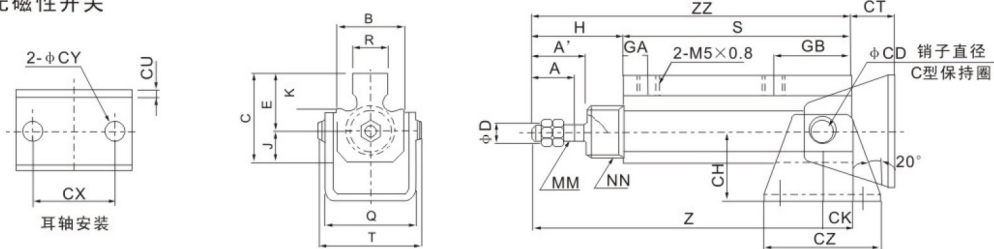
●耳轴型: CJPT/无磁性开关

St: 气缸行程(毫米)

缸径 (mm)	耳轴座 零件号	S					Z					ZZ					R
		5st	10st	15st	20st	30st	5st	10st	15st	20st	30st	5st	10st	15st	20st	30st	
6	CP-T006	35.5	40.5	45.5	50.5	-	48.5	53.5	58.5	63.5	-	52.5	57.5	62.5	67.5	-	7
10	CP-T010	40.5	45.5	50.5	55.5	65.5	54	59	64	69	79	60.5	65.5	70.5	75.5	85.5	8
15	CP-T015	42	47	52	57	67	58	63	68	73	83	66	71	76	81	91	10

缸径(mm)	A	A'	B	C	φD	E	GA	GB	H	J	K	MM	NN	Q	T	φCD	CH	CK	CT	CU	CX	φCY	CZ
6	7	9	14	16.5	3	10.5	6	11	17	6	8	M3×0.5	M10×1.0	18.5	20.4	3	16	4	12	1.6	18	3.4	26
10	10	12	15	20	5	13	6	17	20	7	8	M4×0.7	M12×1.0	20.5	23.9	5	20	6.5	13.5	1.6	24	4.5	33
15	12	14	20	24.5	6	15.5	6	18.5	24	9	8	M5×0.8	M14×1.0	28	31.7	6	25	8	17	2.9	29	5.5	42

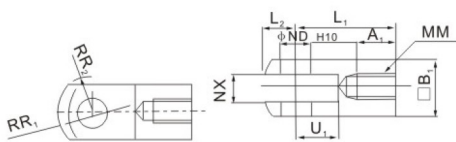
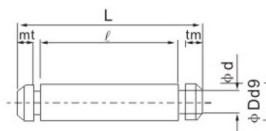
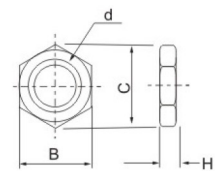
●Y型双肘节接头

●肘节接头销子

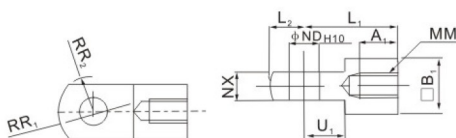
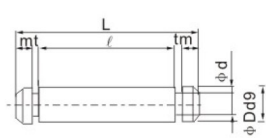
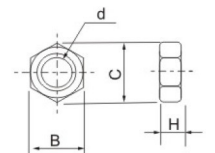
●安装用螺母

适用缸径 (mm)	Y型双肘节接头											肘节接头销子						缸身螺母					
	零件号	A1	B1	φND ^{H10}	L1	L2	MM	U1	NX	R1	R2	零件号	φDd9	L	φd	ℓ	M	t	零件号	d	H	B	C
6	Y-P006	5	6	3 ^{+0.04} ₀	12	3.5	M3×0.5	5	3	5	4	IY-P006	3 ^{-0.025} ₀	9	2.85	6.2	0.75	0.65	SNP-006	M10×1	3	14	16.2
10	Y-P010	6.5	10	5 ^{+0.048} ₀	16	5.5	M4×0.7	7	5	8	6.3	IY-P010	5 ^{-0.030} ₀	13.6	4.8	10.2	1	0.7	SNP-010	M12×1	3	17	19.6
15	Y-P015	7	12	6 ^{+0.048} ₀	19	7	M5×0.8	9	6	10	7.8	IY-P015	6 ^{-0.030} ₀	15.8	5.7	12.2	1	0.8	SNP-015	M14×1	4	19	21.9

●I型单肘节接头

●耳轴销子

●杆端螺母

适用缸径 (mm)	I型单肘节接头											耳轴销子						杆端螺母					
	零件号	A1	B1	φND ^{H10}	L1	L2	MM	U1	NX	R1	R2	零件号	φDd9	L	φd	ℓ	m	t	零件号	d	H	B	C
6	I-P006	5	6	3 ^{+0.04} ₀	12	3.5	M3×0.5	5	3	5	4	CT-P006	3 ^{-0.025} ₀	20.4	2.85	17.6	0.75	0.65	NTP-006	M3×0.5	1.8	5.5	6.4
10	I-P010	6.5	10	5 ^{+0.048} ₀	16	5.5	M4×0.7	7	5	8	6.3	CT-P010	5 ^{-0.030} ₀	23.9	4.8	20.5	1	0.7	NTP-010	M4×0.7	2.4	7	8.1
15	I-P015	7	12	6 ^{+0.048} ₀	19	7	M5×0.8	9	6	10	7.8	CT-P015	6 ^{-0.030} ₀	31.7	5.7	28.1	1	0.8	NTP-015	M5×0.8	3.2	8	9.2